

105 - 28 \*\*WS WS6-F

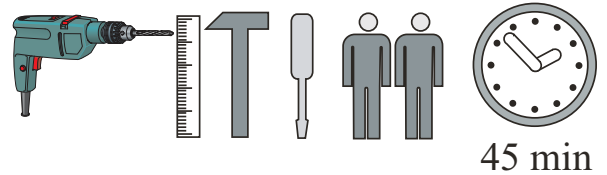

45 min

NO	Dim.			Col.-No	Qty
1	604	286	16	1	1
2	604	286	16	1	1
3	270	286	16	1	2
4	570	270	16	1	1
105	600	298	16	2	1

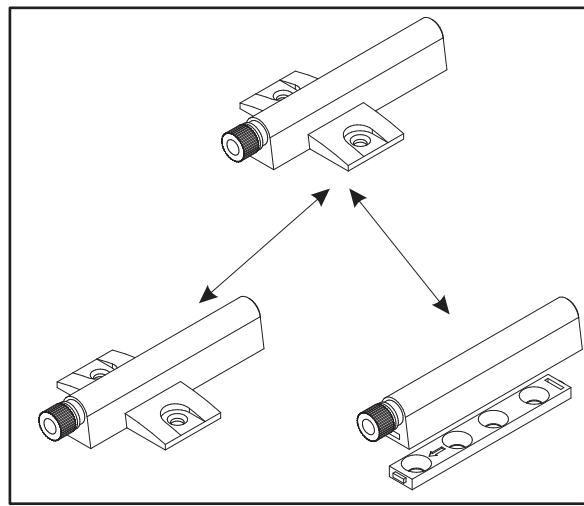
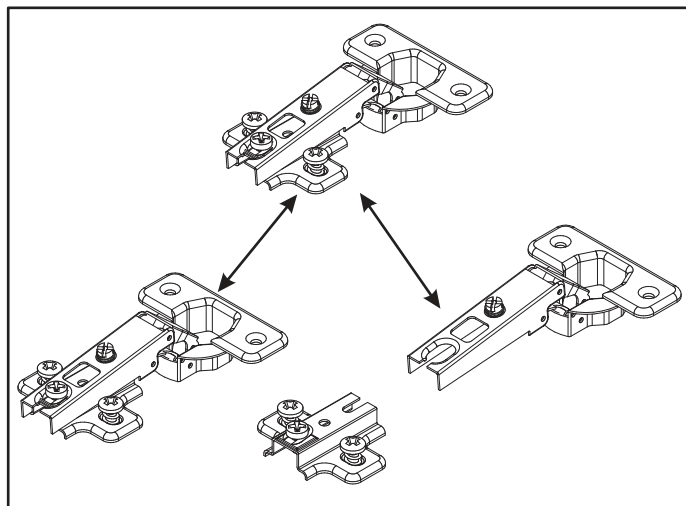
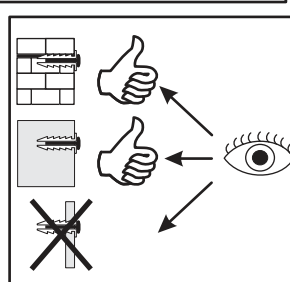
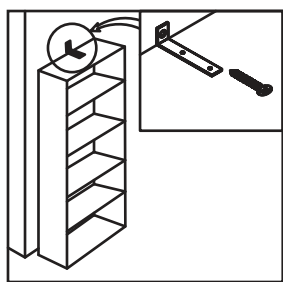
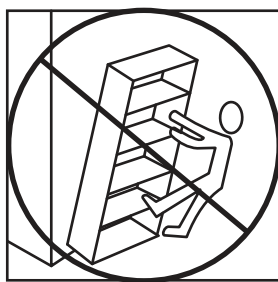
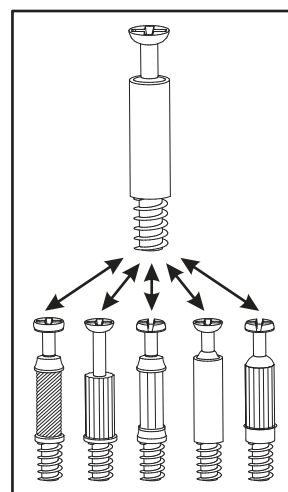
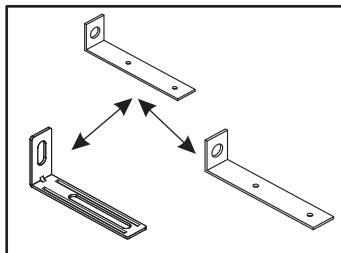
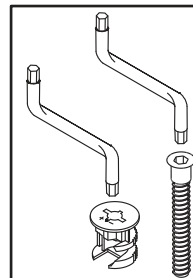
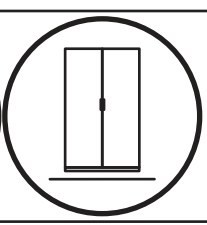
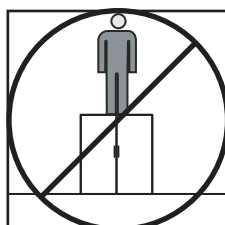
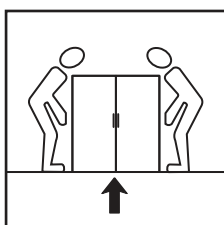
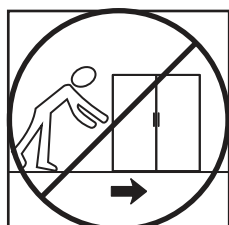
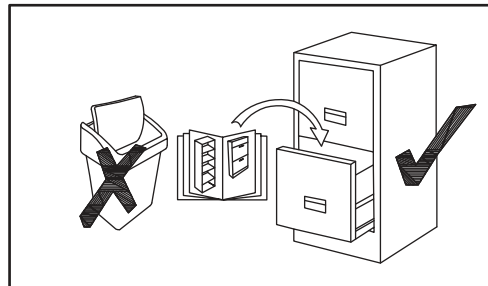
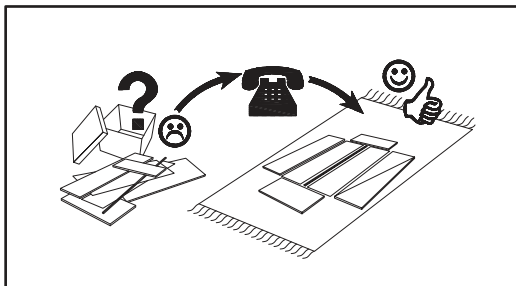
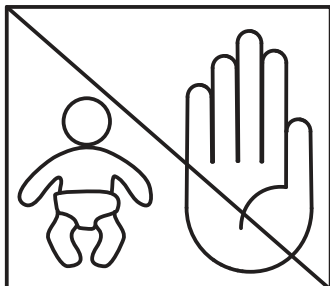
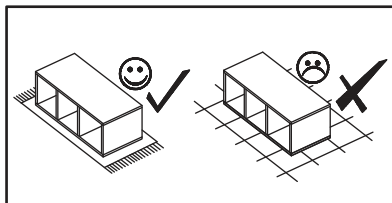
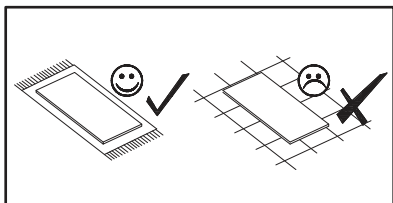

A1 x12 ø8x36	B4 x16	B5 x16 ø15x12	G5 x16	ZM1 x2	D28 x4 ESØ6x9,5
D10 x8 USØ3,5x13	G2 x1	KR2 x2	P3 x2	E21 x2 Ø35 H=0	E2 x2 H=0
Z2 x4 Ø5	T1 x1	BO1 x2			

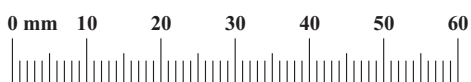

1

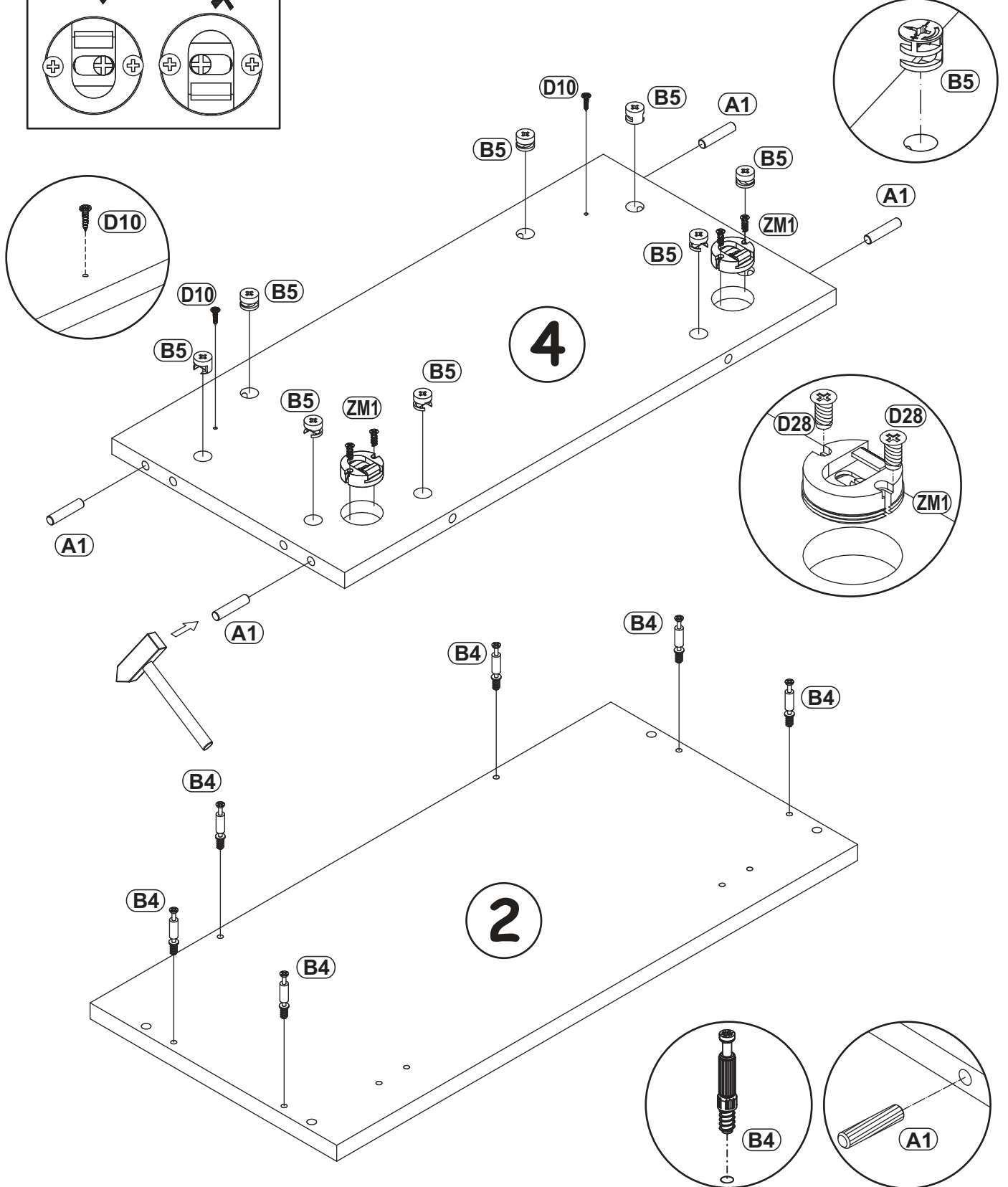
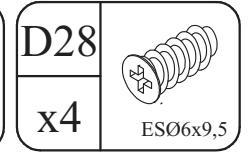
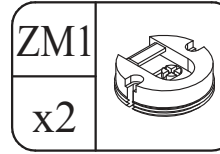
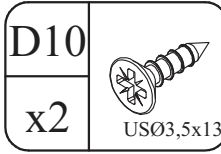
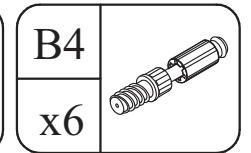
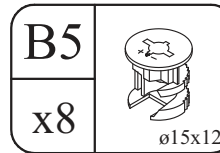
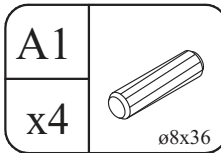
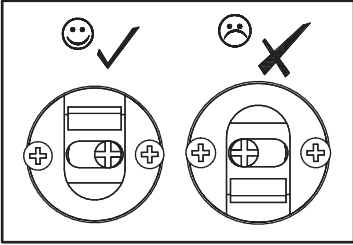
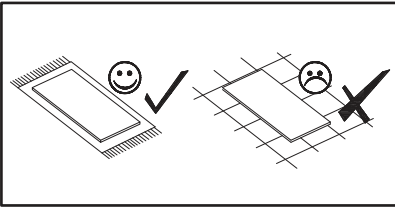

2

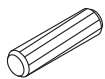
A1	
x8	ø8x36

B5	
x8	ø15x12

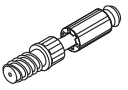
B4	
x10	

2

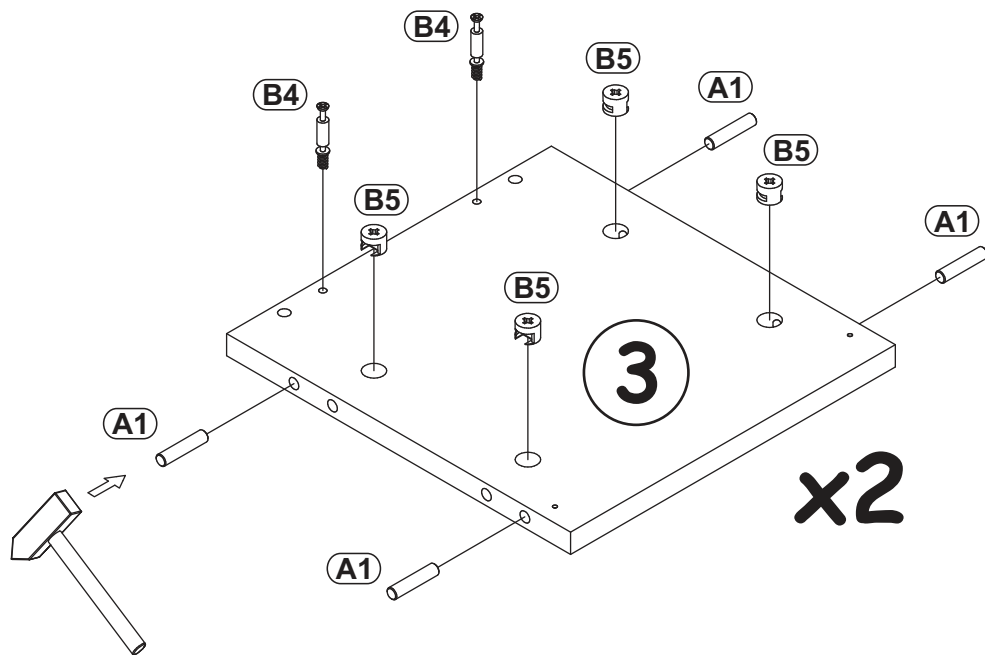
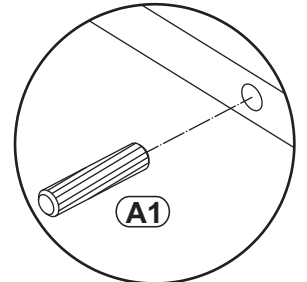
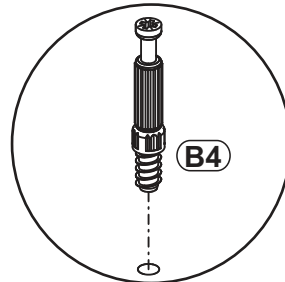
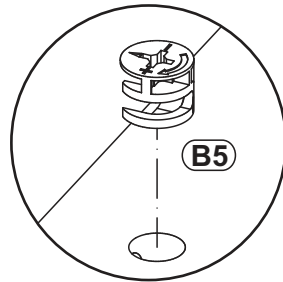
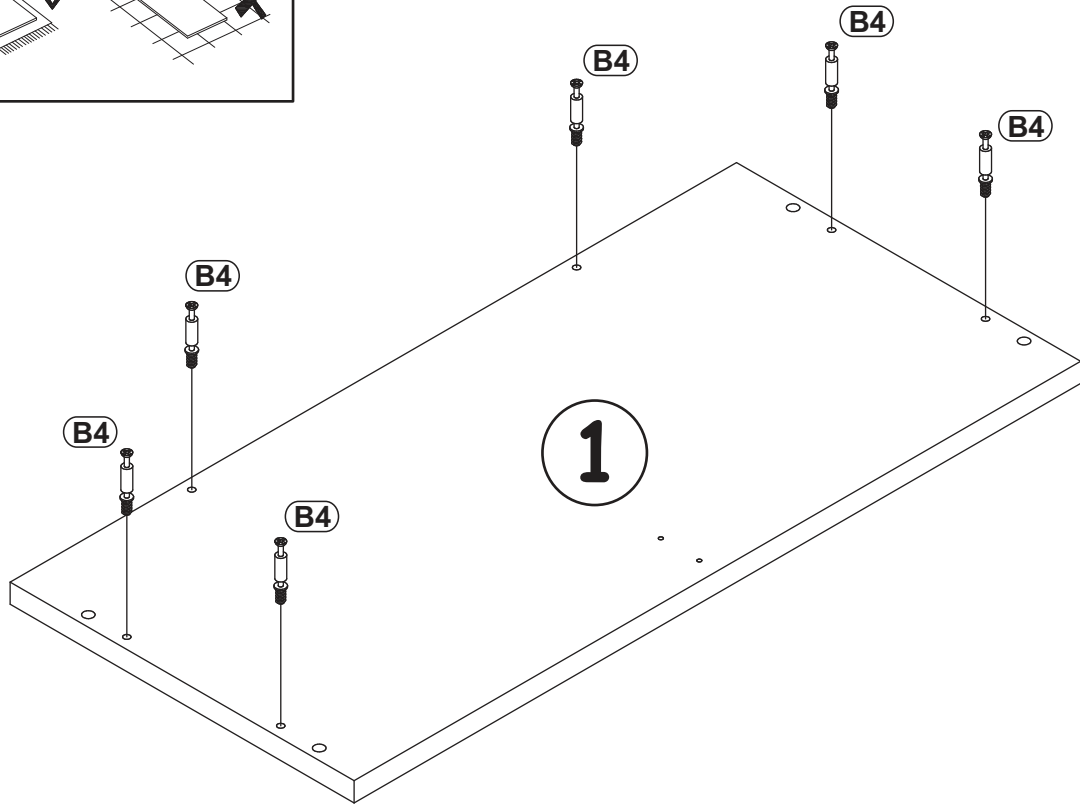
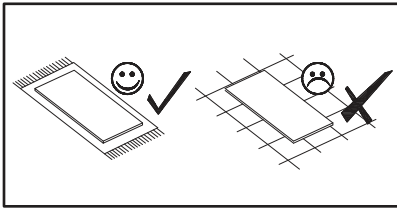

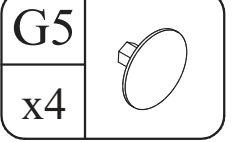

3

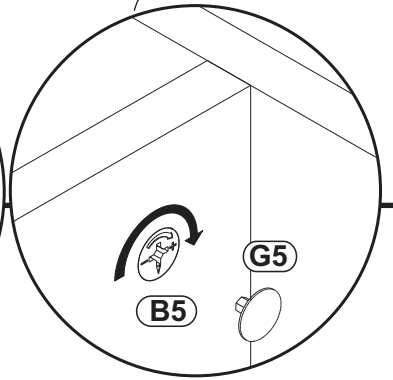
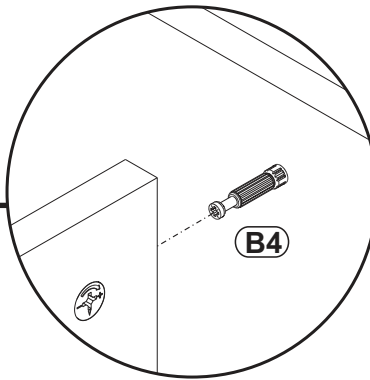
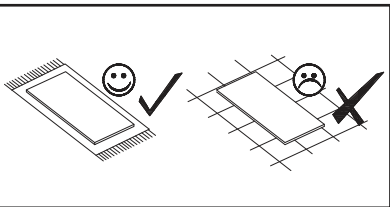
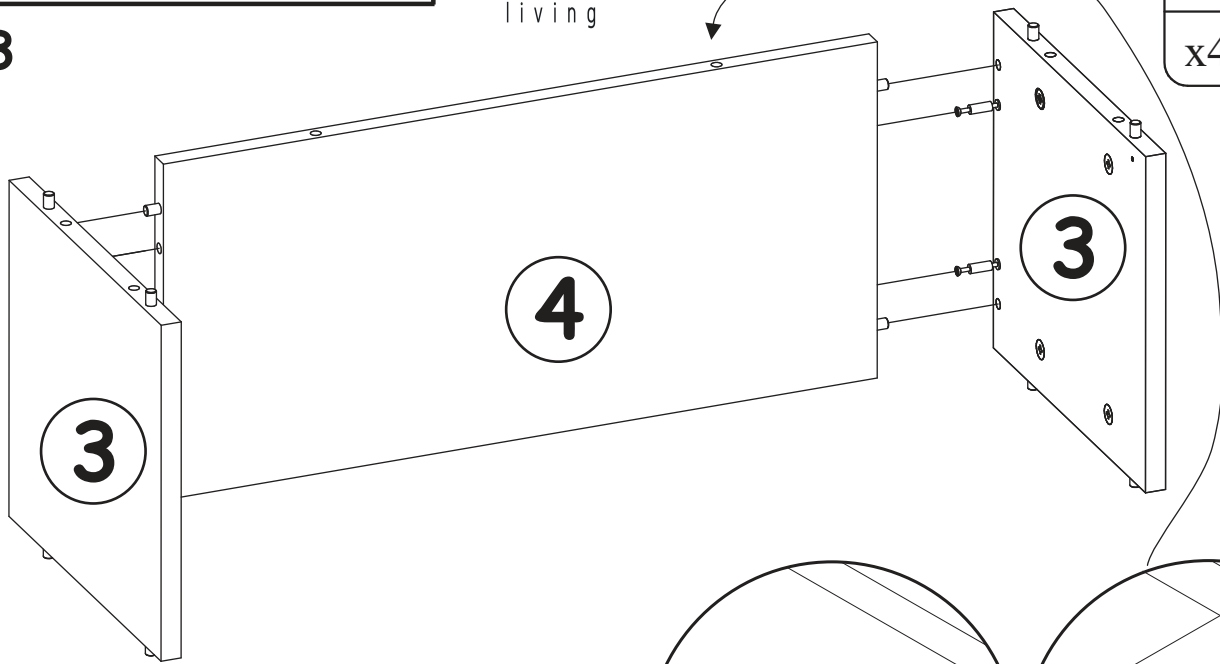

4

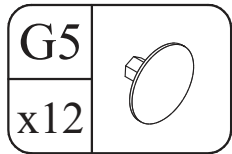
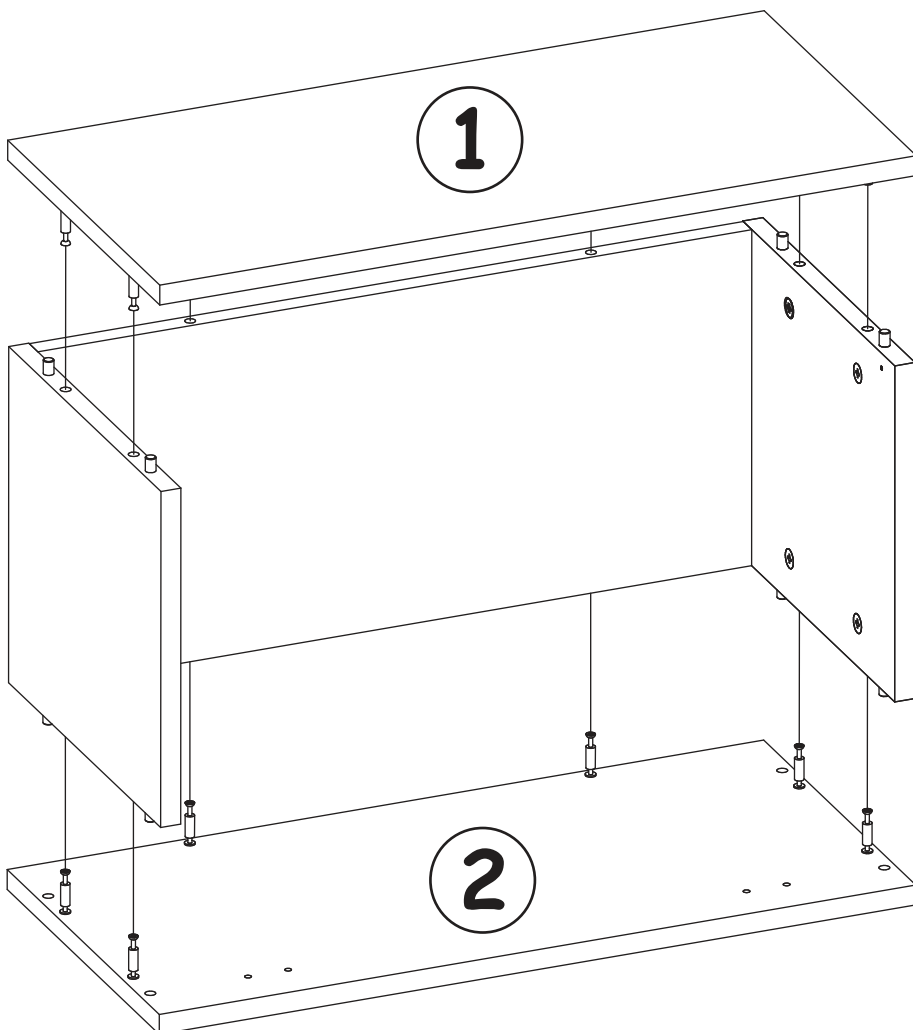

**5-6**

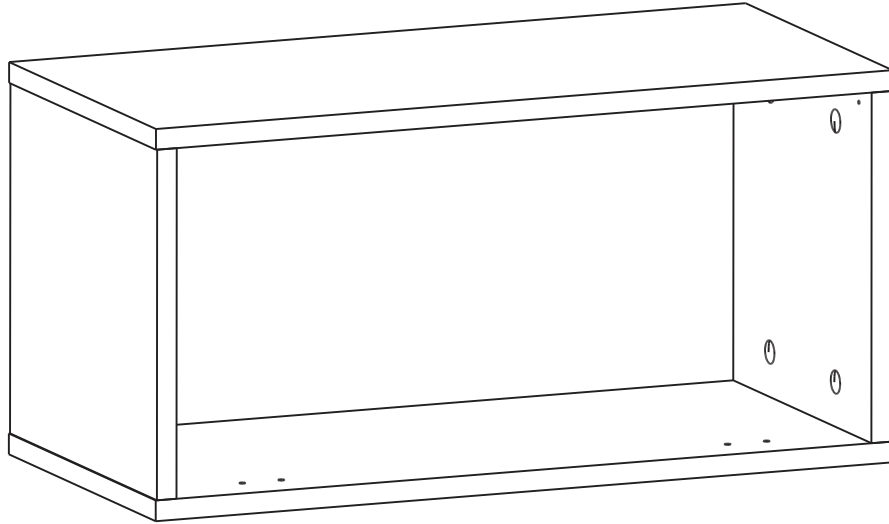

**7 - 11**

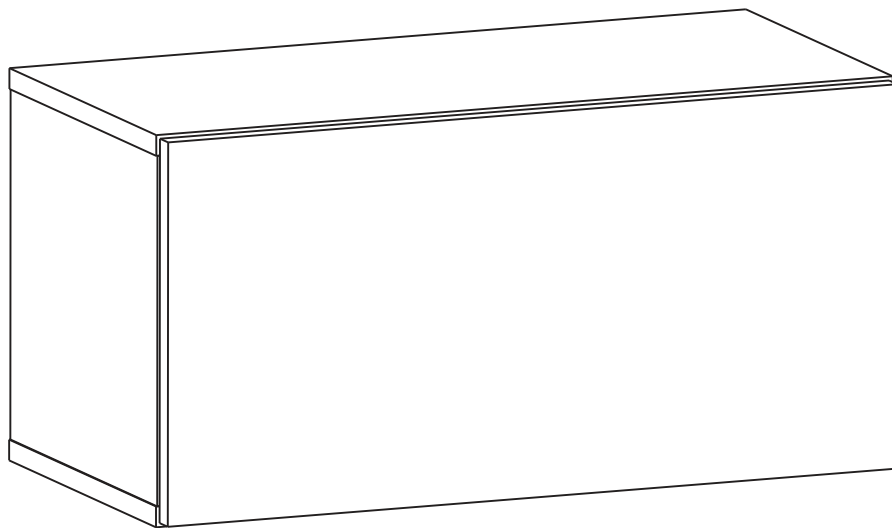

Z2	
x4	Ø5

5

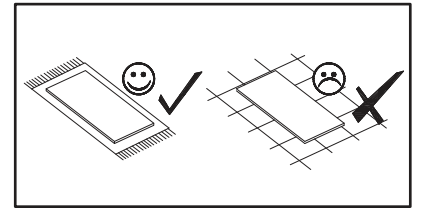
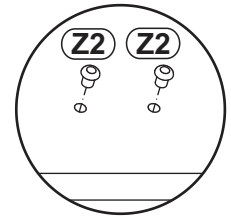
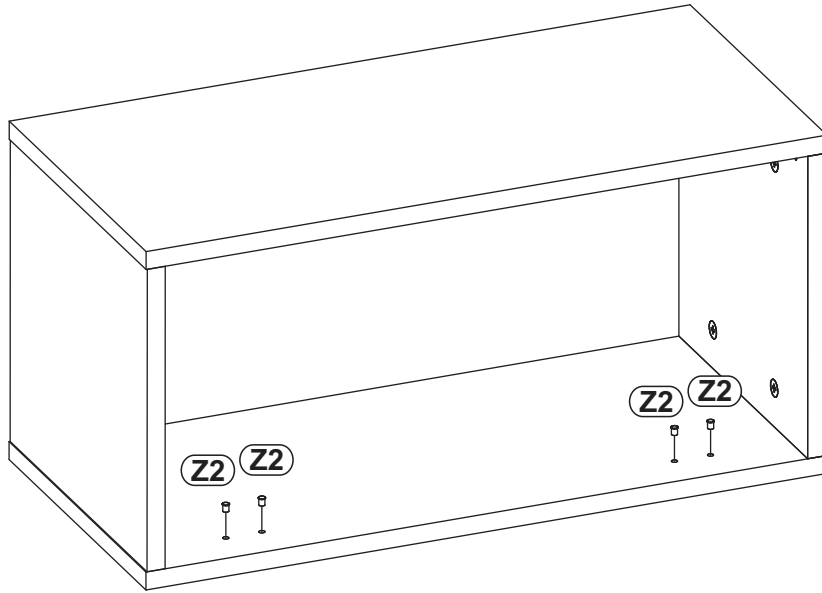

6

430 mm

KR2	
x2	

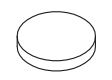
P3	
x2	

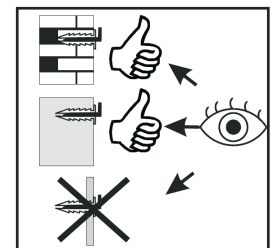
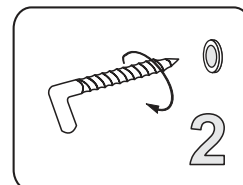
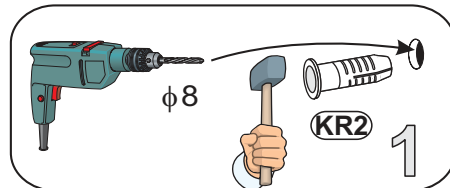
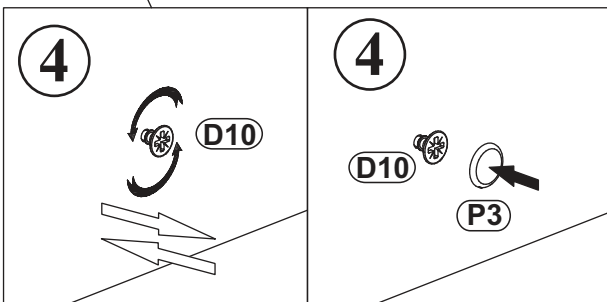
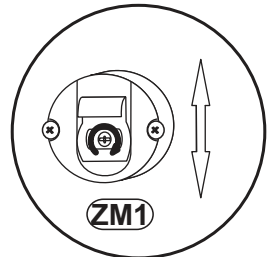
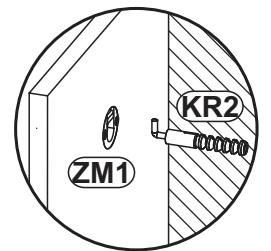
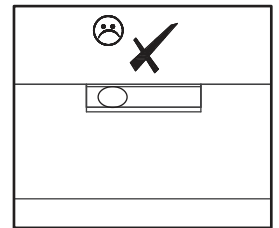
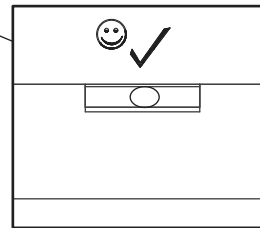
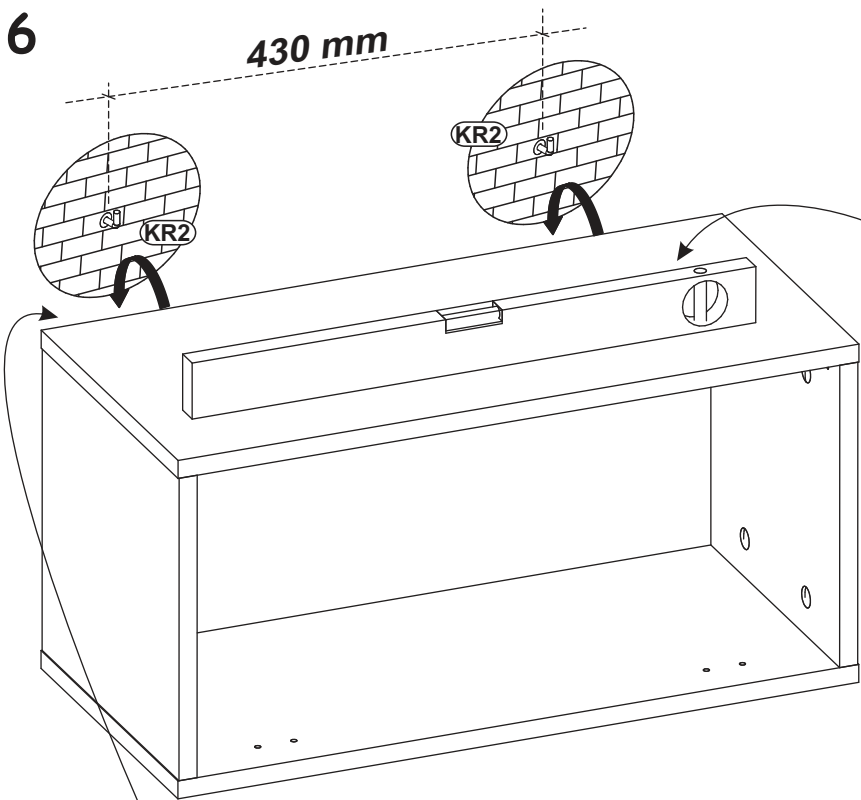

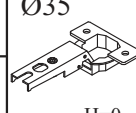

D10	
x4	USØ3,5x13

E21	Ø35
x2	
H=0	

7

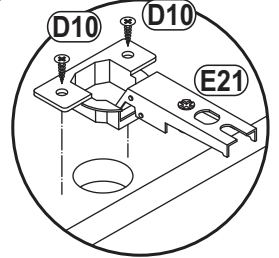
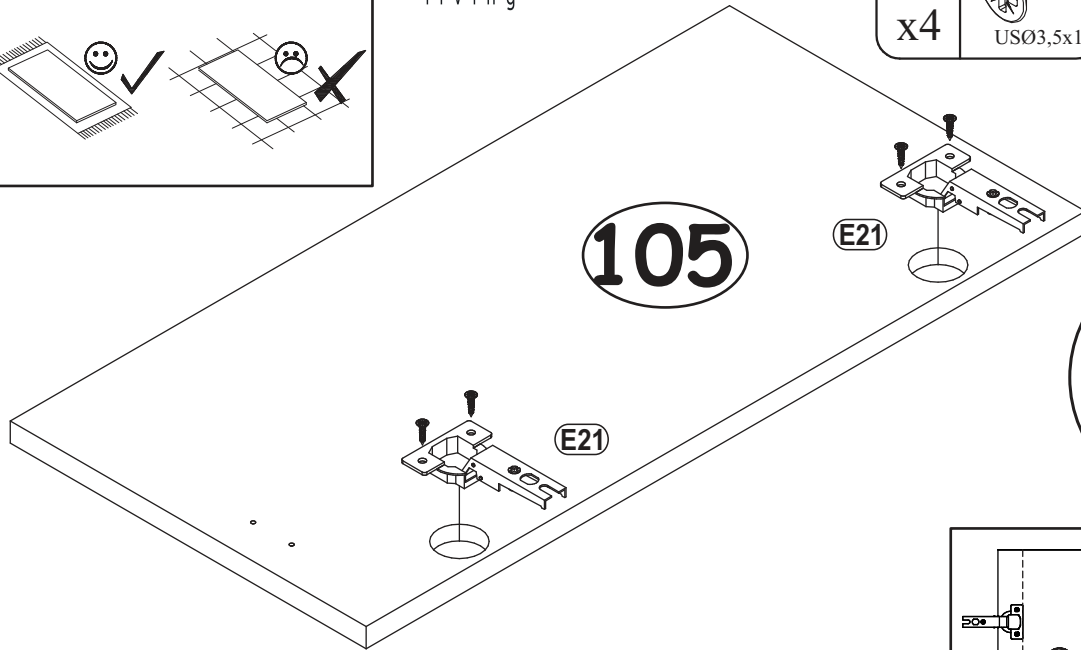
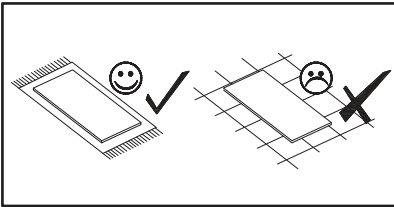

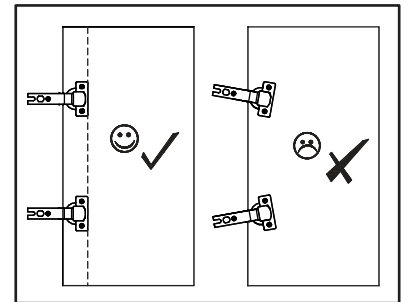

105 - 28 \*\*WS WS6-F

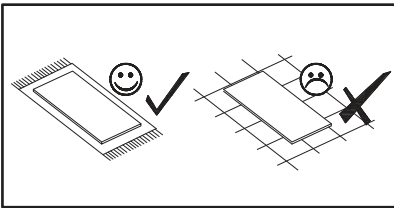

8

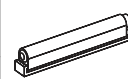

T1	
x1	

D10	
x2	USØ3,5x13

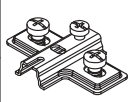
E2	
x2	H=0

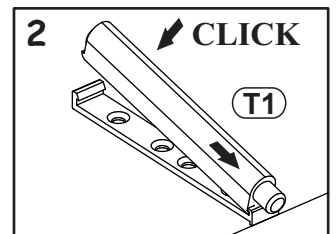
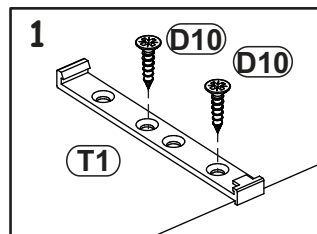
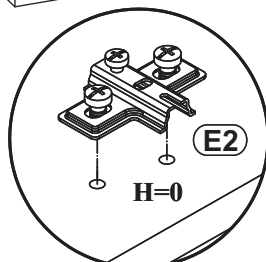
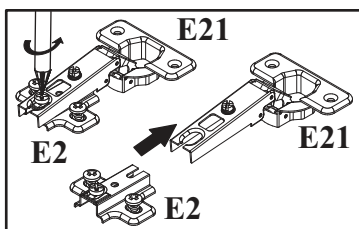
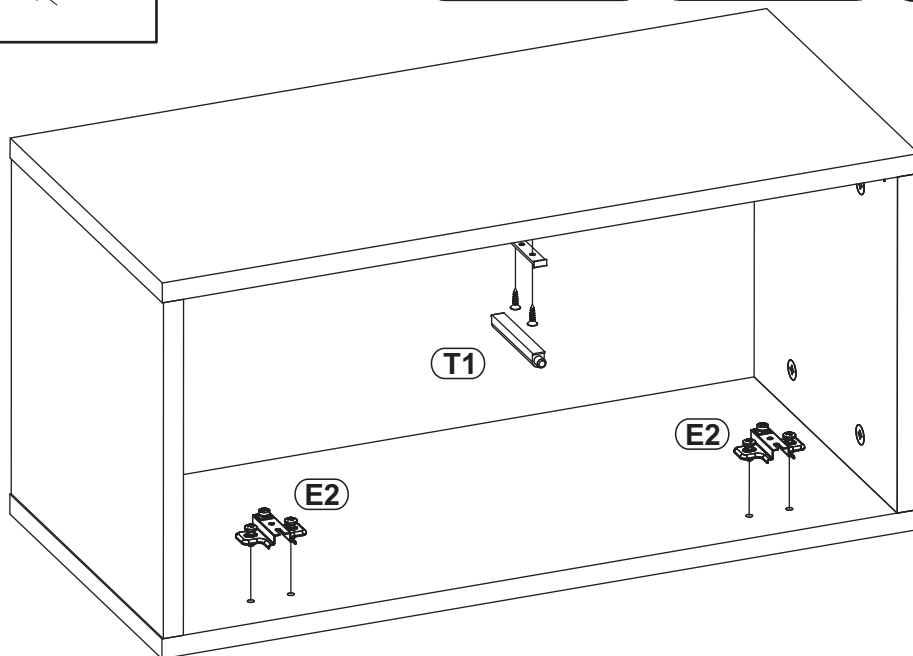

9 **wuun**  
living

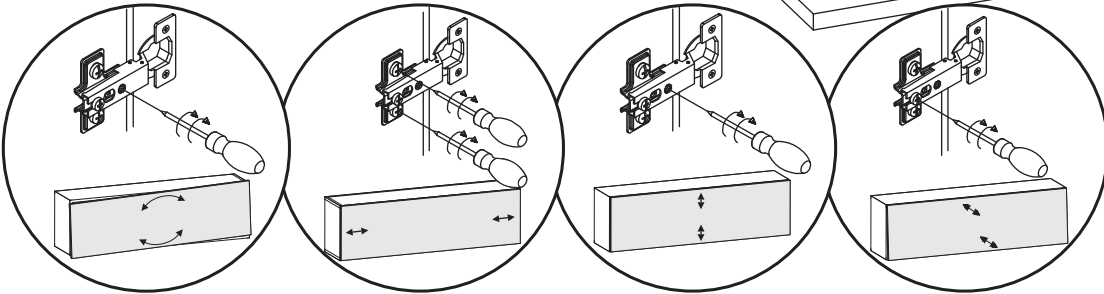
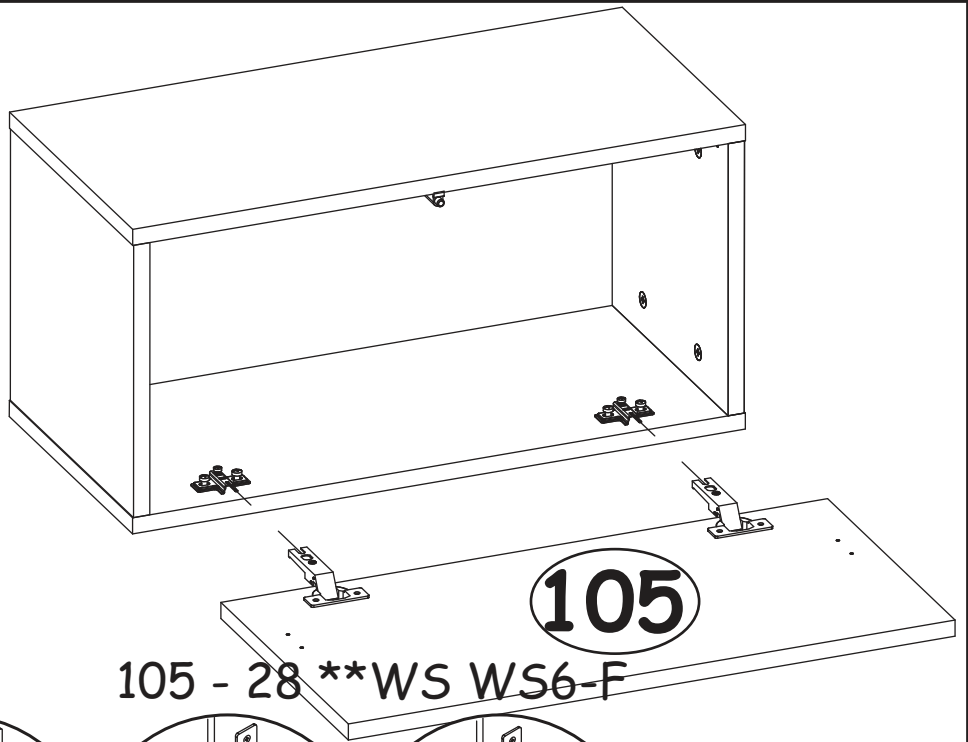
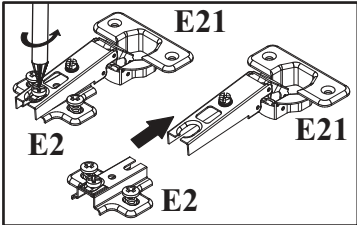
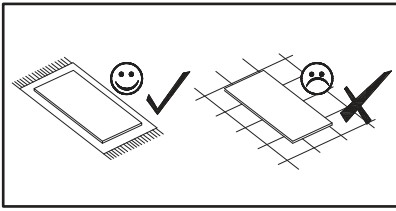

10

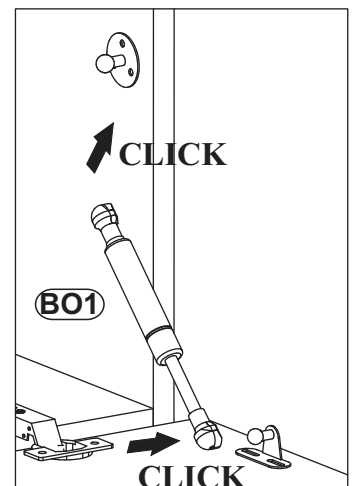
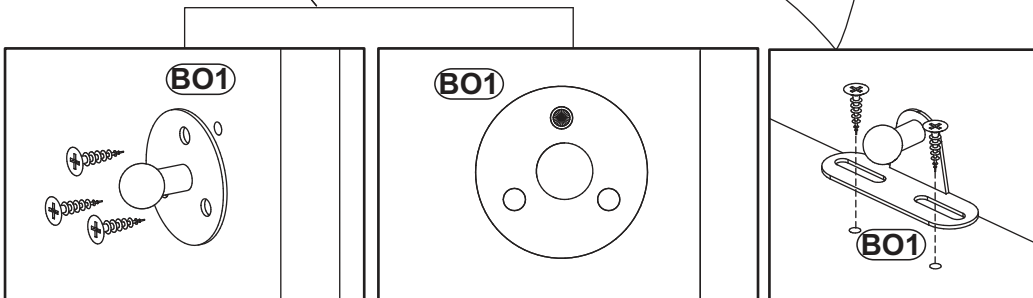
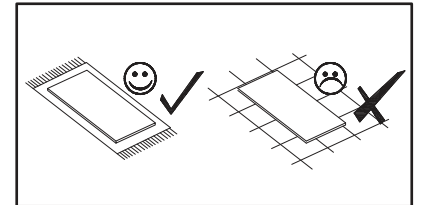
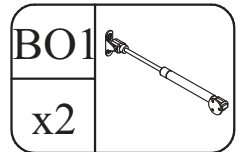
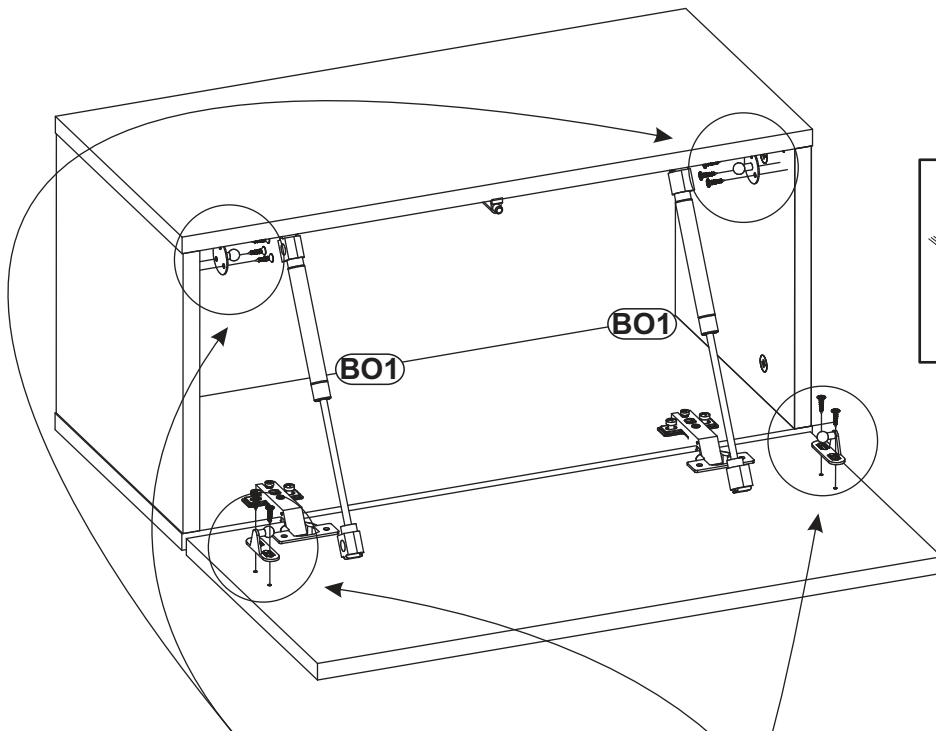

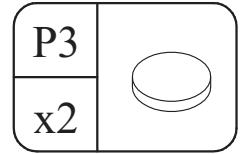
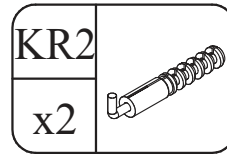

# 11

