

SOMERO 28 _ WS1-K

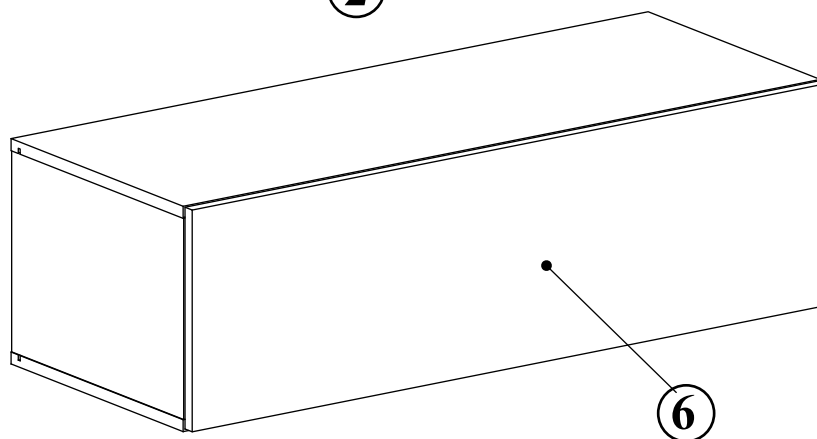

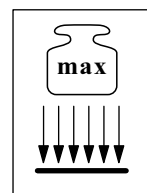

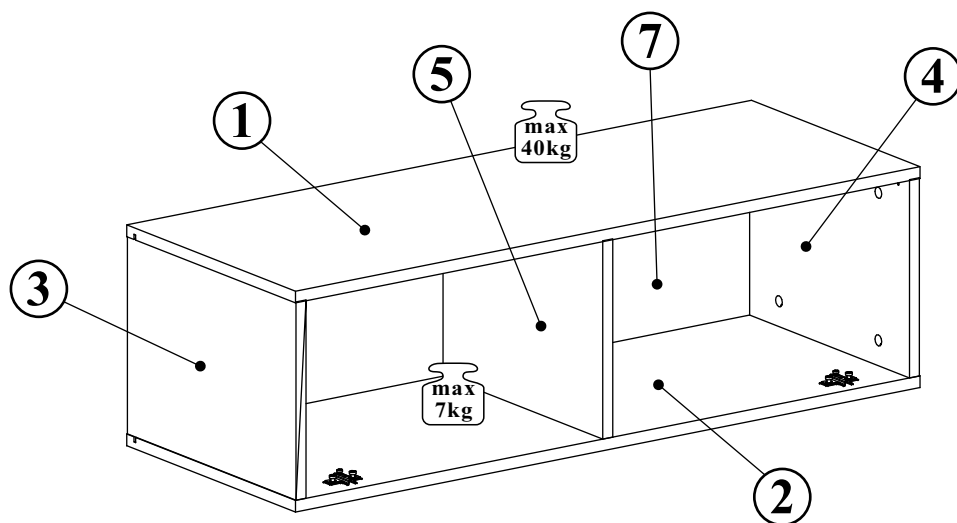



NO	Dim.		Col.-No	Qty
3	270	380	1	1
4	270	380	1	1
1	1002	380	1	1
2	1002	380	1	1
5	270	360	1	1
7	979	282	1	1
6	996	296	1	1

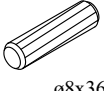
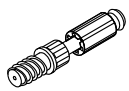

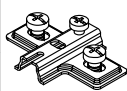
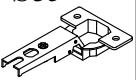
90 min

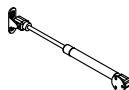
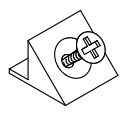
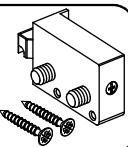
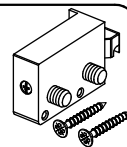
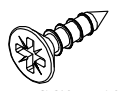
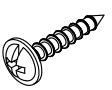
SOMERO 28 __ WS1-K

A1 x12  ø8x36	B4 x12 	B5 x12  ø15x12	G5 x12 	E2 x2  H=0	E21 x2  Ø35 H=0
T1 x1 	BO1 x2 	S1 x10 	ZXL x2 	ZXP x1 	D10 x6  USØ3,5x13
UP13 x2  UPØ3x16	G2 x1 	KR2 x3 			

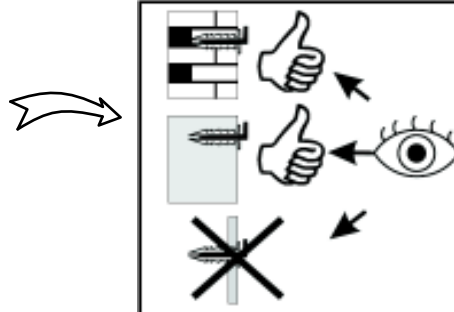
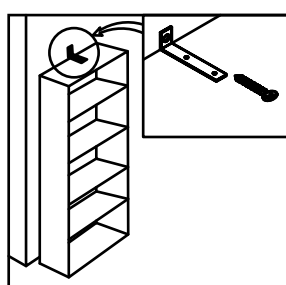
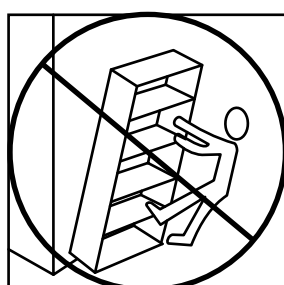
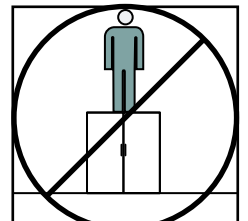
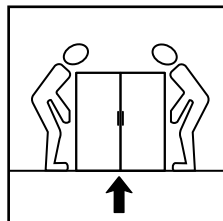
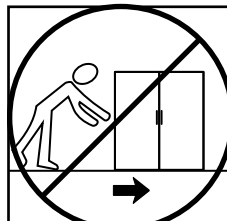
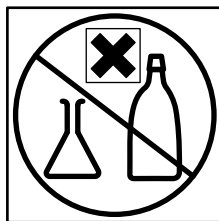
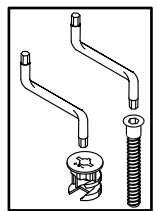
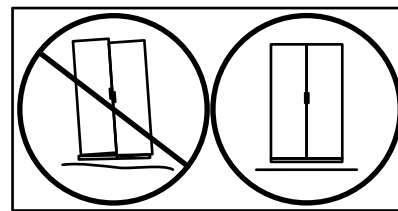
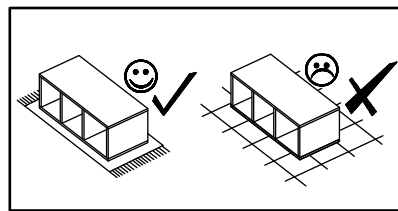
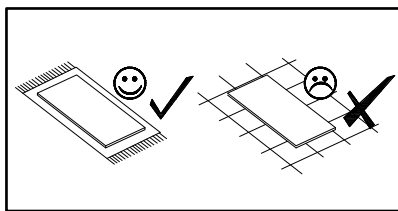
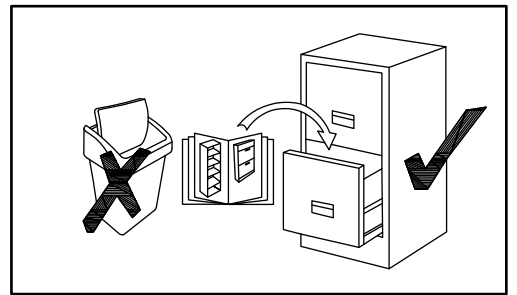
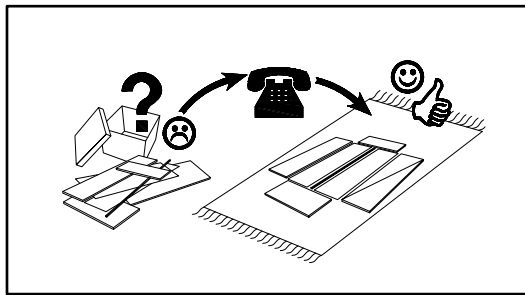
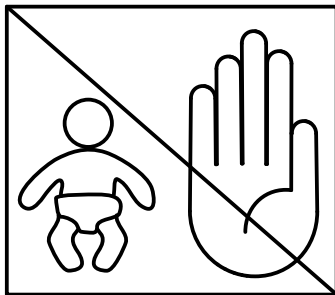
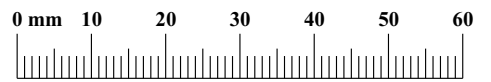

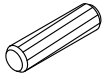
B5		A1	
x12	ø15x12	x12	ø8x36

1

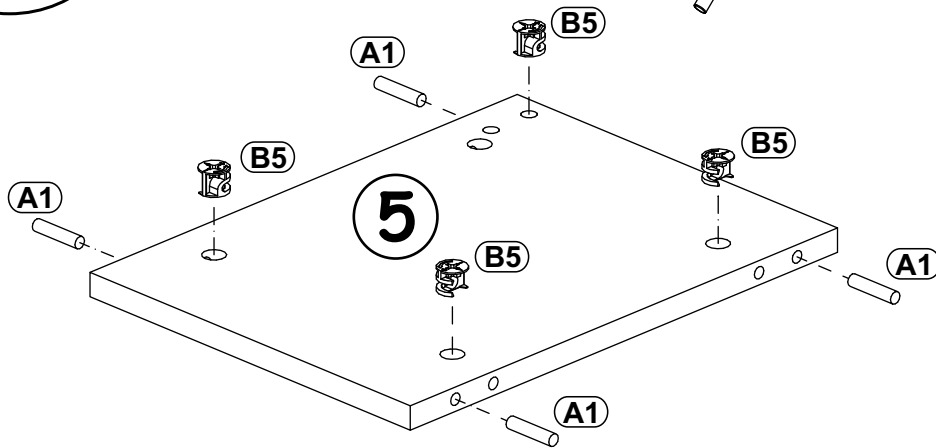
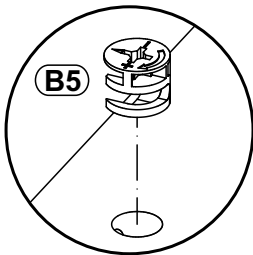
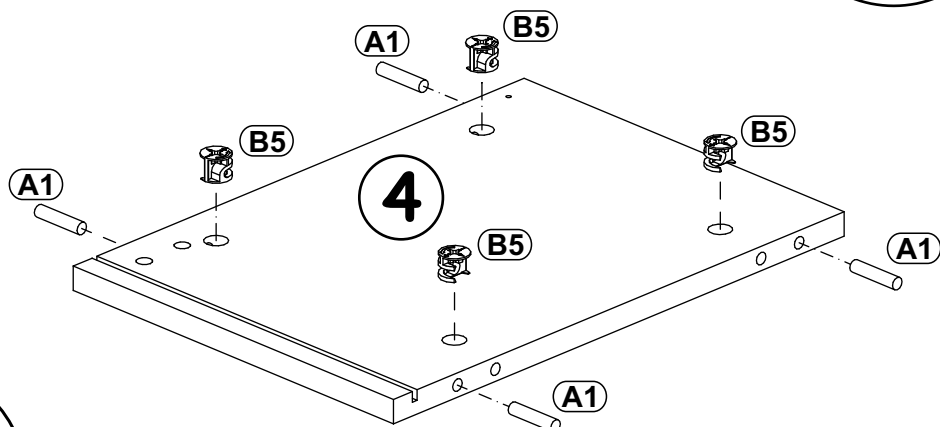
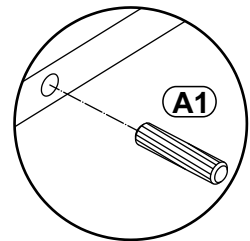
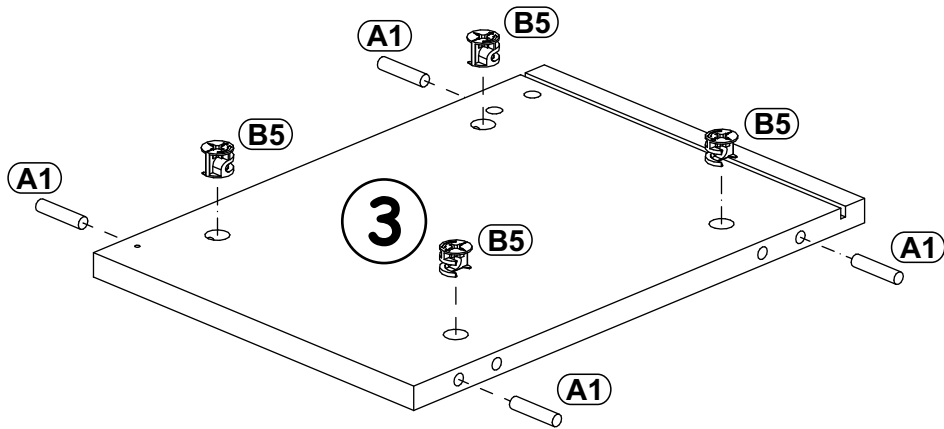

2

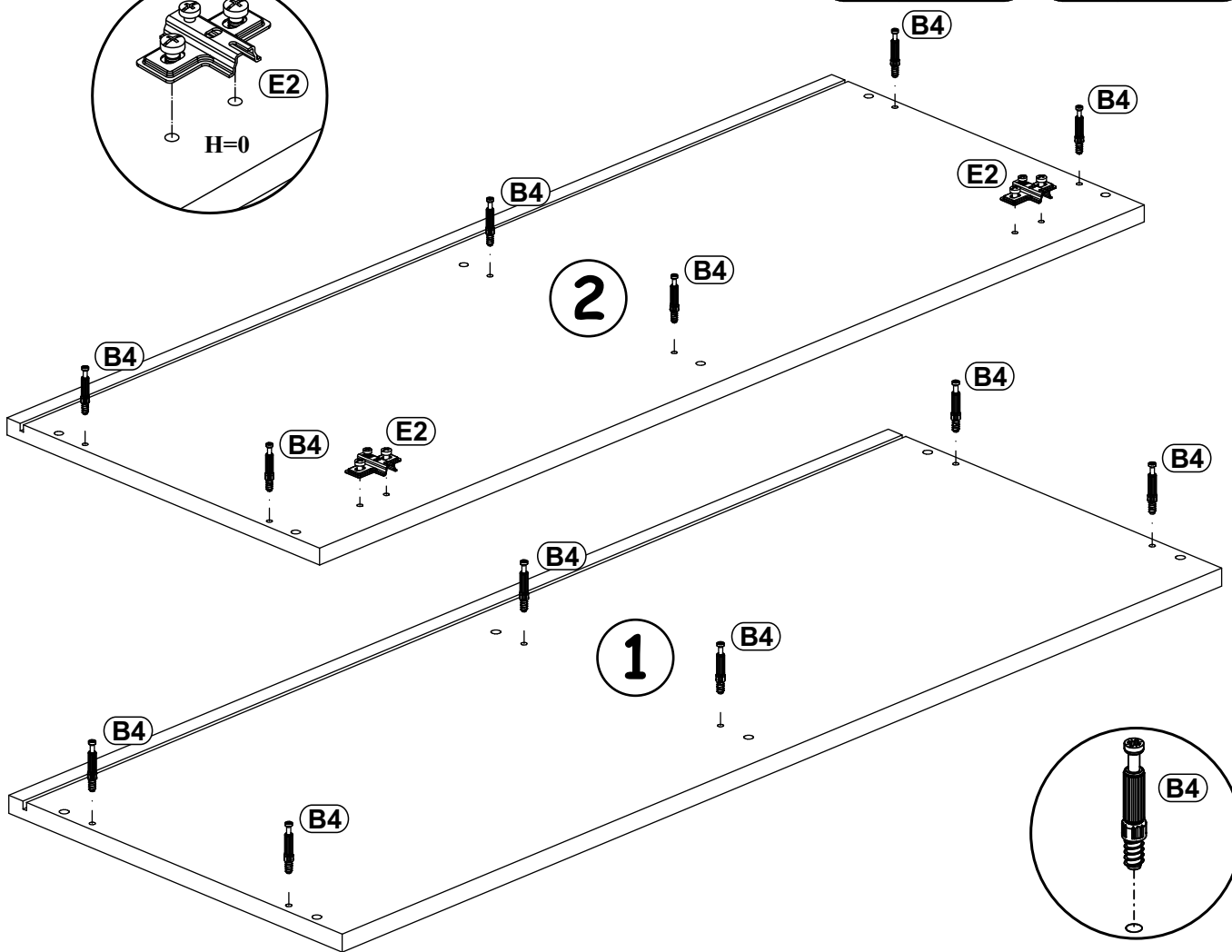
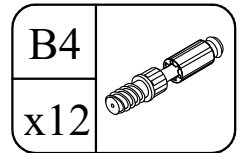
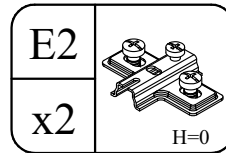
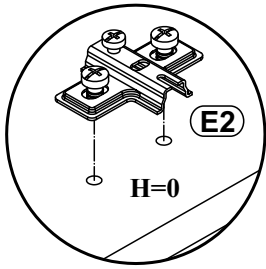

3

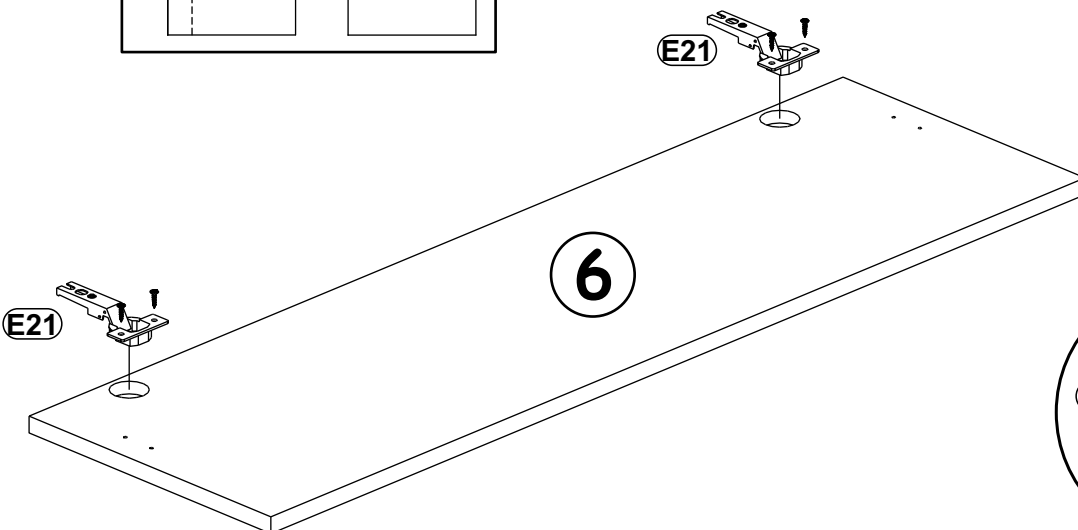
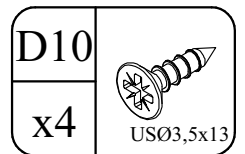
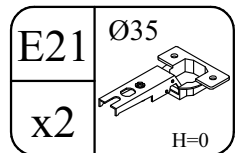
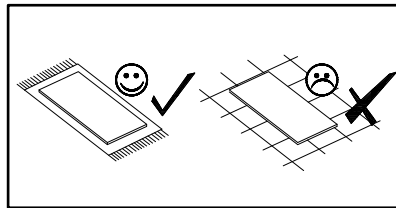
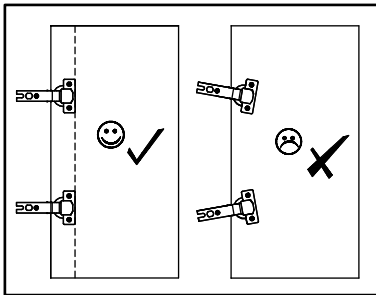

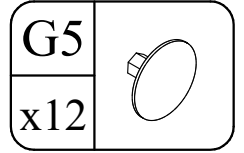

4

a)

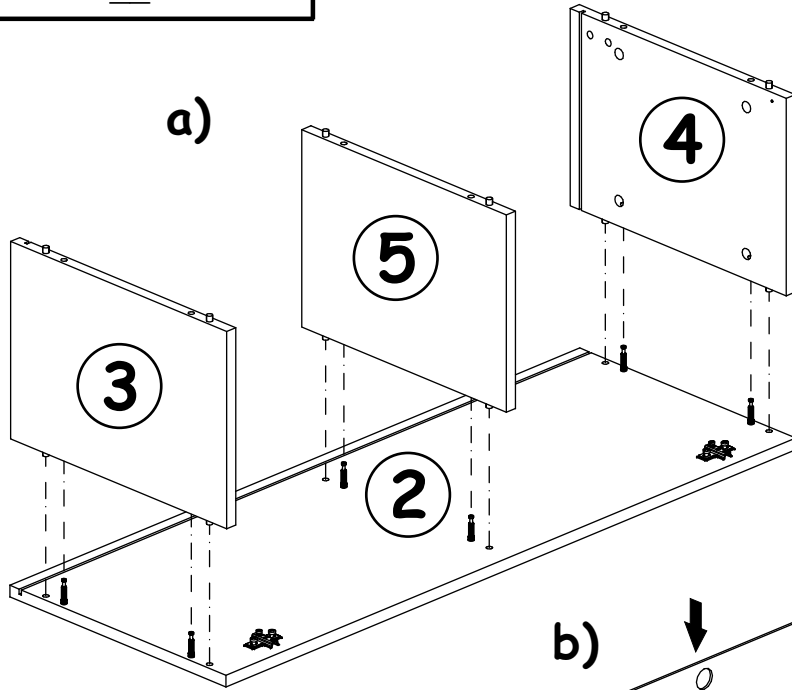

b)

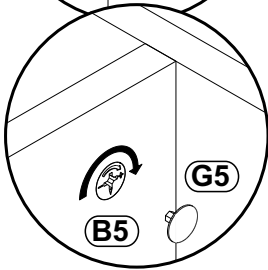
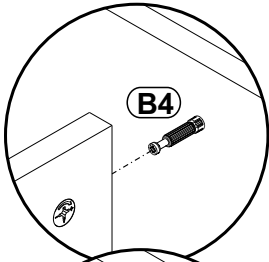
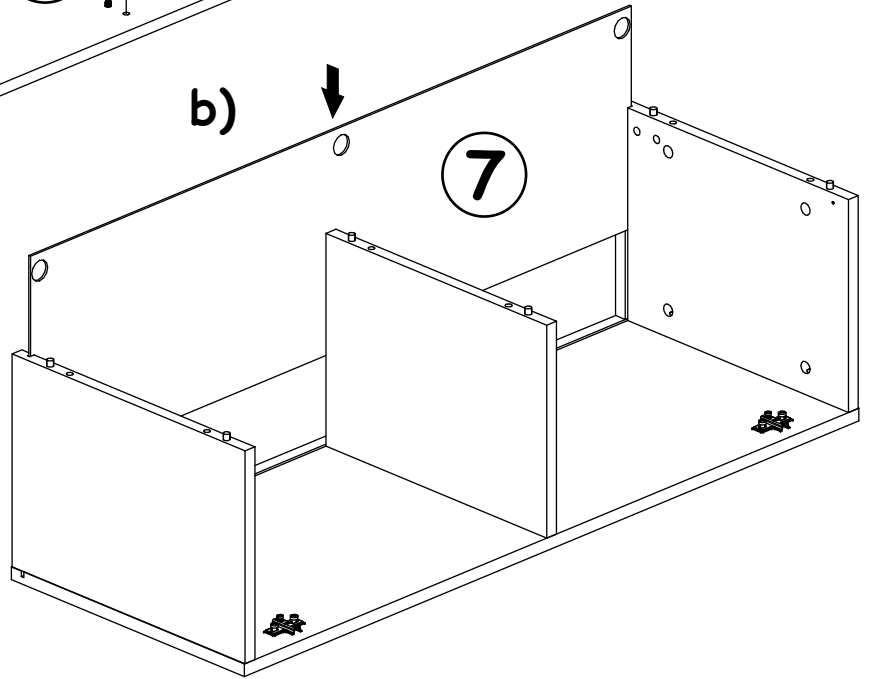

c)

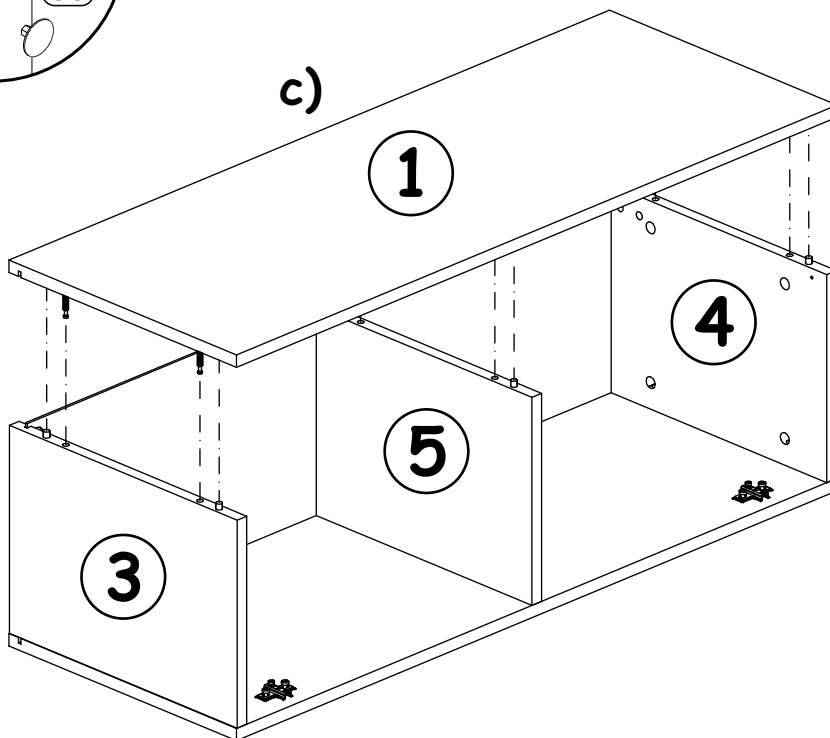

5

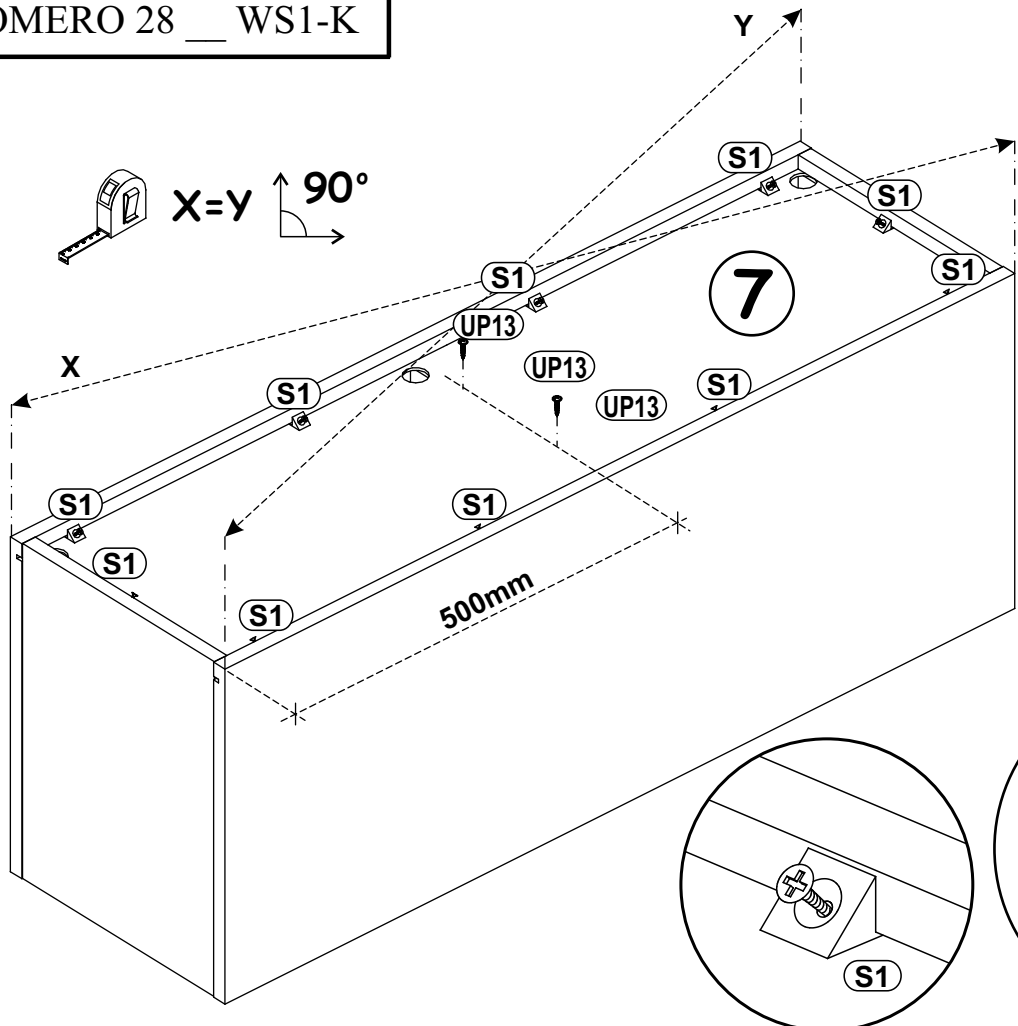

UP13	
x2	UPØ3x16

S1	
x10	

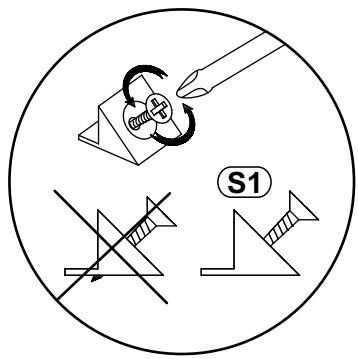
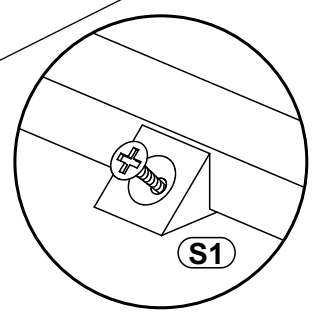
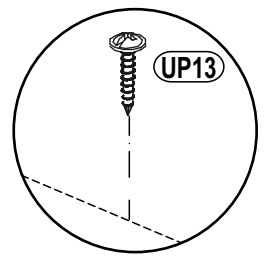

6

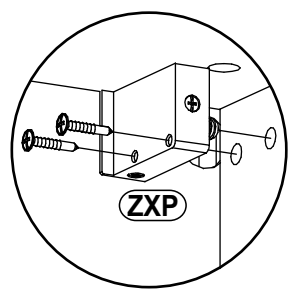
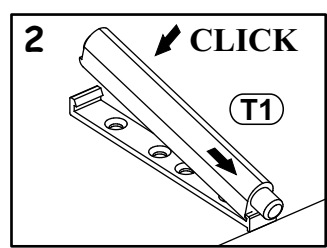
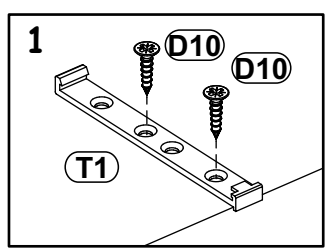

ZXP	
x1	

T1	
x1	

D10	
x2	USØ3,5x13

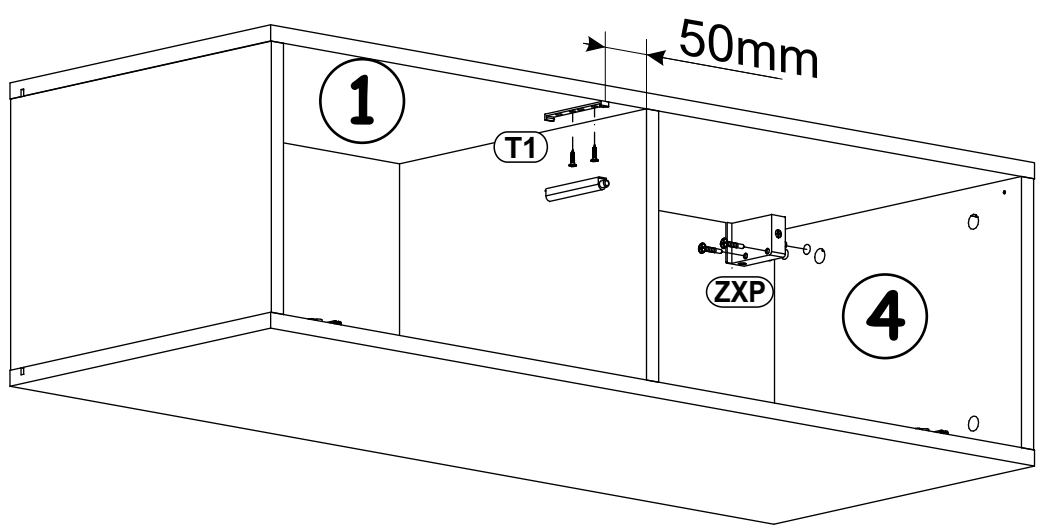

7

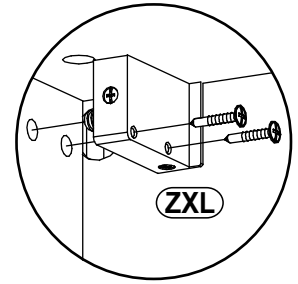
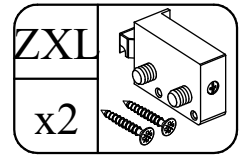
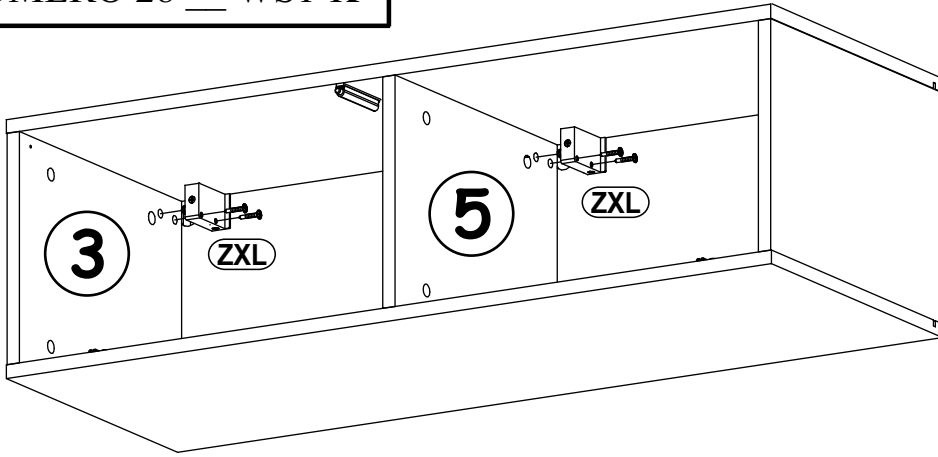

8

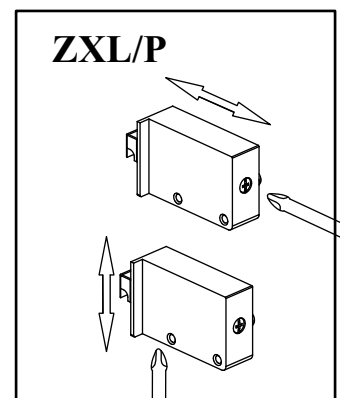
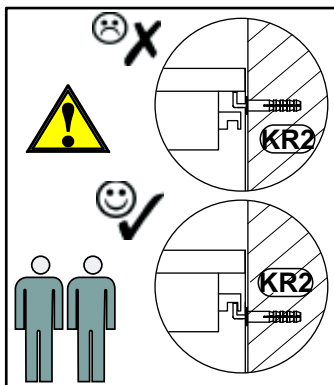
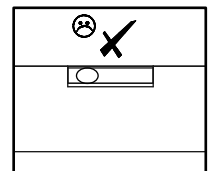
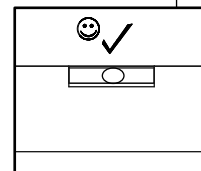
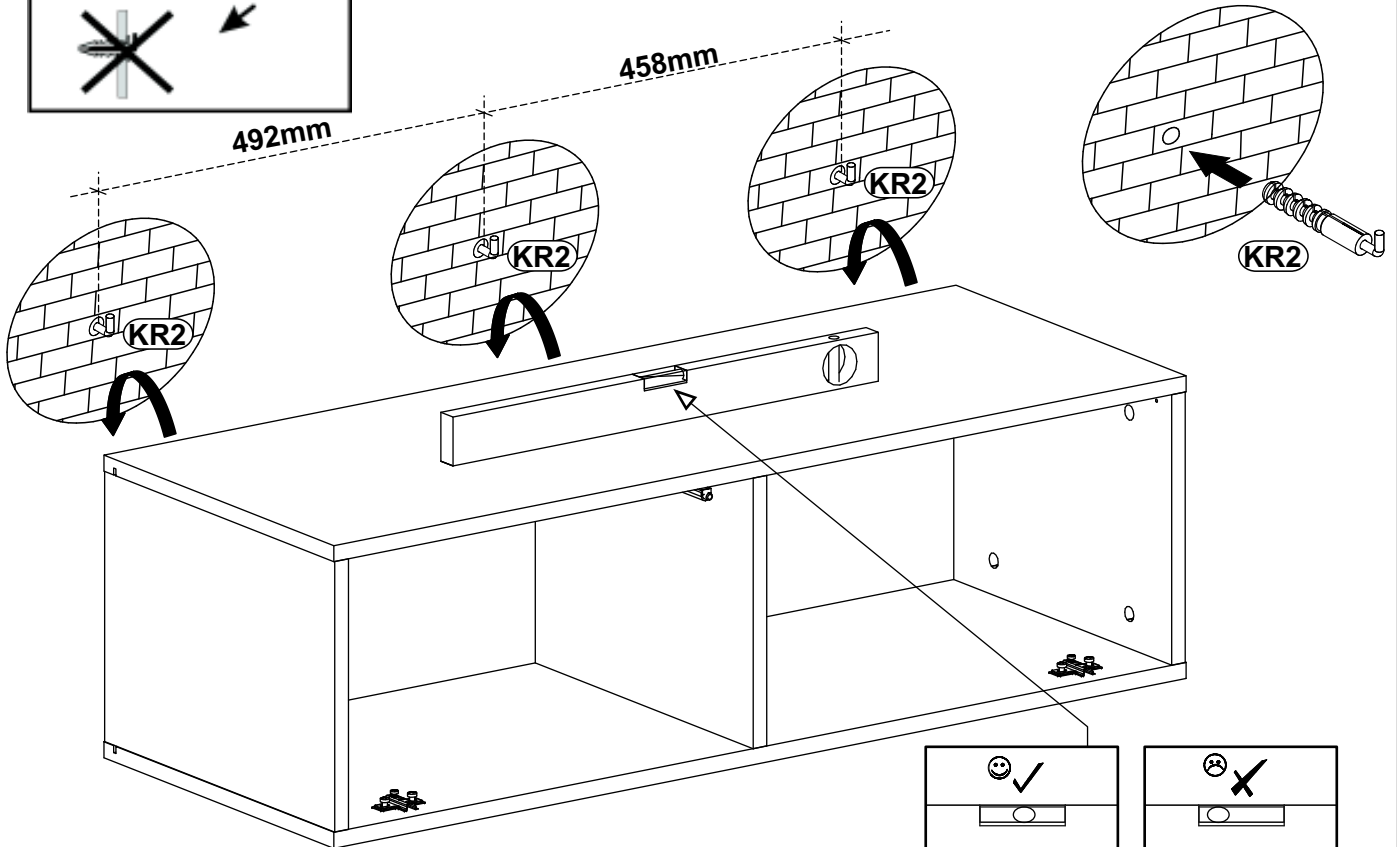
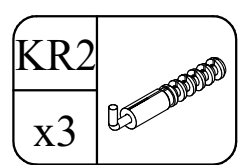
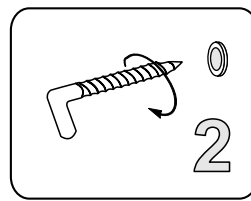
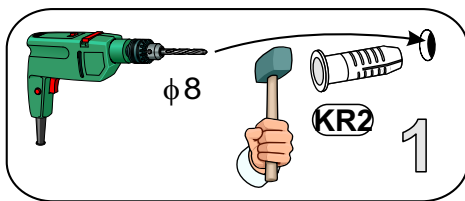
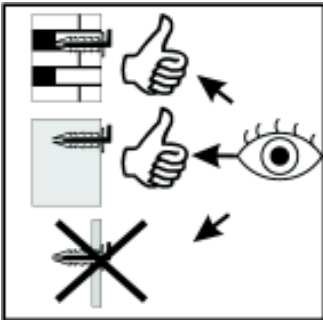

9

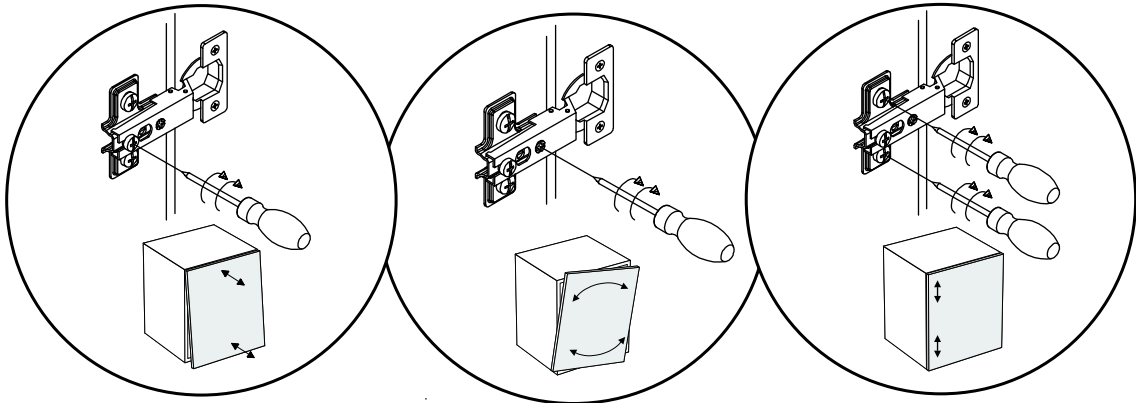
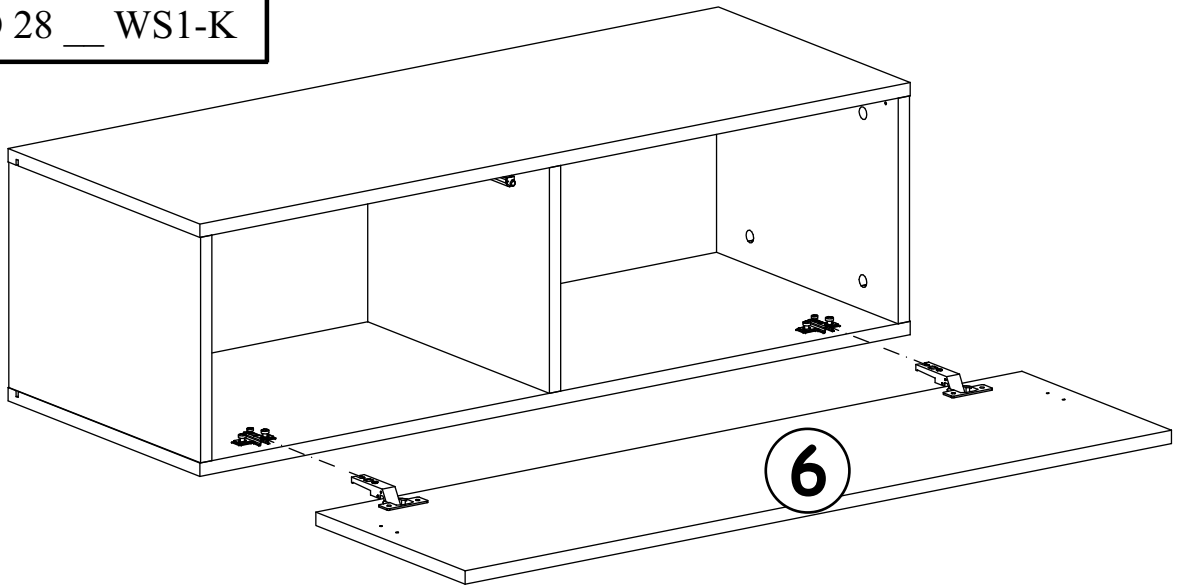

10

